

青岛源泉机械有限公司
Qingdao Yuanquan Machinery Co., Ltd.

SINCE 1985

PRODUCT
CATALOG

产品册

动物纤维梳理机械
Animal Fiber Carding Machinery

青岛源泉机械有限公司
Qingdao Yuanquan Machinery Co., Ltd.

青岛总公司: 13505325035 (张)
国际业务部: 13256827480 (王)
地址: 山东省青岛市胶州市洋河镇艾山工业聚集区
邮箱: yq01@yuanquanmachinery.com
中文官网: www.qdyuanquan.com (Chinese)
英文官网: www.yuanquanmh.com (English)
阿里巴巴国内: https://yuanquan.1688.com
阿里巴巴国际: http://qdyuanquanmachine.en.alibaba.com



English



中文

追求卓越品质 - 缔造世界品牌
BEST QUALITY TO CREATE A WORLD BRAND

企业介绍

COMPANY INTRODUCTION

青岛源泉机械有限公司始建于1985年，是一家专业从事动物纤维分梳设备，无纺设备，研发制造的生产型企业，集研发、生产、销售于一体。自公司成立以来，坚持以动物纤维分梳设备的研发、制造为主线，同时有效发展小型纺纱打样设备、非织造布全套设备的制造与市场开发。目前公司已经形成了“一基两翼”的产品线格局，即以动物纤维分梳设备的生产、销售为基础，以小型纺纱打样设备和非织造布全套设备的制造为两翼，为源泉机械的发展、壮大提供源源不断的动力。

Qingdao Yuanquan Machinery Co., Ltd. was founded in 1985. It is a production-oriented enterprise specializing in the R&D and manufacturing of animal fiber carding equipment and non-woven equipment, integrating R&D, production and sales. Since the establishment of the company, it has adhered to the research and development and manufacturing of animal fiber carding equipment as its main line, and at the same time effectively developed the manufacturing and market development of small spinning sampling equipment and a complete set of non-woven equipment. At present, the company has formed a "one base and two wings" product line structure, that is, based on the production and sales of animal fiber carding equipment, with the manufacturing of small spinning sampling equipment and a complete set of non-woven equipment as two wings, and as the source of Yuanquan Machinery. Development and growth provide a steady stream of power.



企业荣誉

CORPORATE HONOR

Authorized Patent



Certificate



Software copyright



Utility patent



发展历程 DEVELOPMENT HISTORY

先进的技术 精致的设计 精湛的制造 创造出优质的产品
ADVANCED TECHNOLOGY EXQUISITE DESIGN CREATE HIGH-QUALITY PRODUCTS



In 1995

公司拓展经营范围，增加喷胶棉生产线和针刺生产线等并进行家纺类产品生产设备的制造与销售。
Our company expanded the business scope and added thermal bonded production line and needle punching production line, and engaged in the manufacturing and sales of home textile product.

In 2008

2008年公司将负压吸风技术与羊绒分梳技术相结合，经反复试验和改进最终推出了负压全自动羊绒分梳生产线。
In 2008, after repeated experiments and improvements, the company finally launched a negative pressure fully automatic cashmere carding production line.

In 2003

公司在宁夏建立新的办事处，这进一步巩固了我司在宁夏以及周边地区的市场地位，增强了我司的服务覆盖能力。
We have established a new office in Ningxia, which further consolidates our company's market position in Ningxia and surrounding areas and enhances our company's service coverage capabilities.

In 2001

公司为满足日益激烈的生产要求和更远的发展计划，投资建设了新的办公楼和厂房。
In order to meet the increasingly fierce production requirements and longer-term development plans, our company built new office buildings and factories.

In 1985

公司成立，主营业务为纺织机械设备的零配件加工、金属切割及焊接制造、安装和销售业务。
Established in 1985, its main business is textile machinery and equipment spare parts processing, metal cutting and welding manufacturing, installation and sales.

In 2014

为适应日益繁盛的的国际业务需求，源泉机械在2014年组建了外贸部，为公司国际市场的拓展提供了基本的动力保障。
Yuanquan Machinery established a overseas market department in 2014, providing basic driving force for the company's expansion in the international market.

In 2017

追求卓越 缔造辉煌
2017年11月3日，伴随着响亮的锣鼓声，青岛源泉机械有限公司在“青岛蓝海股权交易中心”正式挂牌上市，股权简称源泉机械，股票代码800838。
"Qingdao Blue Ocean Equity Trading Center" on 3rd/Nov/2017. The successful listing of Yuanquan Machinery in Blue Ocean Equity is a full affirmation of our company's years of stable development, marking that Yuanquan's development has entered a new stage.

In 2018

我司与蒙古国羊毛纺织协会签订战略合作协议，并与会长刚巴特合作设立源泉-乌兰巴托售后服务中心。
Our company signed a strategic cooperation agreement with the Mongolian Wool Textile Association, and cooperated with Chairman Gangbat to establish the Source-Ulaanbaatar after-sales service center.

In 2019

为响应青岛市政府产业升级，我司在艾山工业园投资建设新厂房，并与次年完成搬迁。
In response to the industrial upgrading of the Qingdao Municipal Government, our company invested in the construction of a new factory in Aishan Industrial Park and completed the relocation the following year.

In The Future

源泉机械将坚持以客户为中心，实现“源泉智造”的持续和谐发展。
Yuanquan Machinery will adhere to customer-centricity and achieve the sustainable and harmonious development of "Yuanquan Intelligent Manufacturing".

In 2022

精益求精 锦上添花
2022年源泉机械获胶州市科技和工业信息化局评为规模以上企业，产值达人民币1亿2千万。这是源泉机械发展历程中的重要里程碑，标志着我们在资金实力、管理水平、市场影响等多个方面达到了较高水平。
The output value reaches 120 million RMB. This is an important milestone in the development process of Yuanquan Machinery, marking that we have reached a high level in various aspects such as financial strength, management level, and market influence.

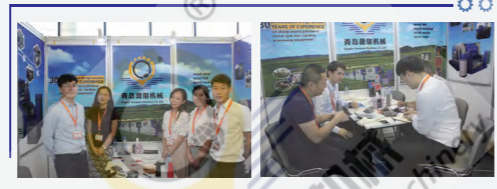

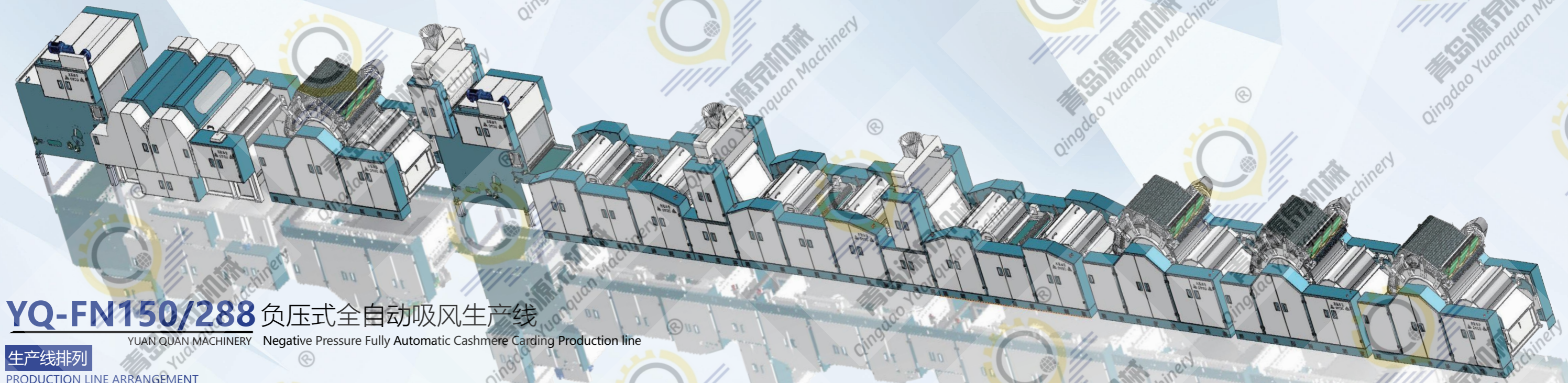

YQ-FN150/288 负压式全自动吸风生产线

YUAN QUAN MACHINERY Negative Pressure Fully Automatic Cashmere Carding Production line

生产线排列
PRODUCTION LINE ARRANGEMENT

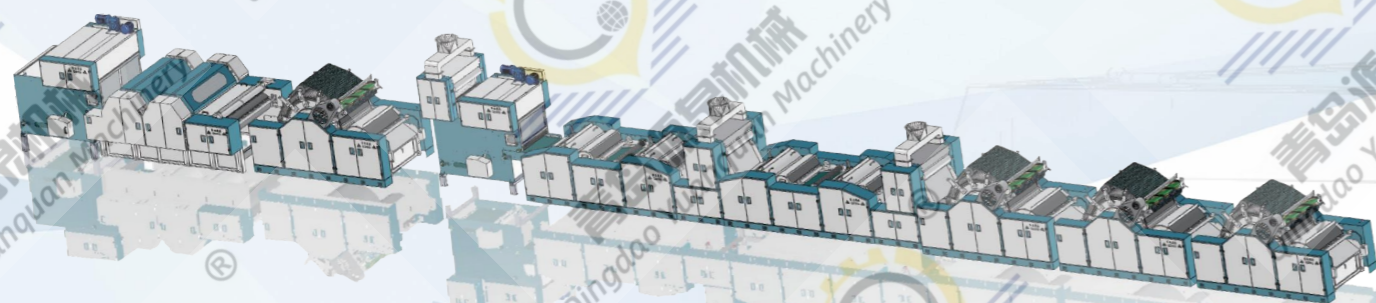

产品介绍 PRODUCT INTRODUCTION

本机主要用于梳理山羊绒、绵羊毛、牦牛绒、驼绒等动物纤维。各单元结合使用，逐步开松梳理去粗、去杂、去皮，最后制成标准的无毛绒。
The machine is used for carding cashmere, sheep wool, camel hair, yak hair and other animal fibers. Through opening and carding step by step, it can remove the dirt, dust and peel, and finally to get the high quality dehaired cashmere.

产品特点 PRODUCT CHARACTERISTIC

- (1) 自动化程度高，节约人工成本，同时增强了员工操作的安全性。
- (2) 采用PLC可编程控制器，具有自动测速，变频调速，控制互锁及手动和自动控制等功能，可以实现工艺参数的在线监测和调整。
- (3) 车间可以配备办公室智能可视化系统，实现数据共享和远程移动终端的命令化控制，能有效监督生产车间的工作实情。
- (4) 采用风吸风送的自动化技术，能够在技术上保证分梳工艺的统一性，减少因工人人为因素造成的无毛绒品质差异。
- (5) 整体设备提取率相较于普通设备从传统的92%提高到95%，纤维损伤率进一步降低，从传统损伤率5%降低到2%，提高了绒的品质。



产品特点 PRODUCT CHARACTERISTIC

- (1) High degree of automation, which saves labor and enhances the safety of workers during operating.
- (2) The control system adopts the PLC programmable controller, it has functions such as automatic speed measurement, frequency conversion speed regulation, control interlocking and manual and automatic control. In this way, it can achieve the crafts parameters detect and adjust online.
- (3) The workshop can be equipped with an intelligent visualization system to achieve data sharing and remote mobile terminal command control, which can effectively supervise the actual work of the production workshop.
- (4) Adopting automated technology of air suction and air supply can ensure the uniformity of the de-hairing process and reduce the difference in de-haired cashmere quality caused by human factors.
- (5) Compared with ordinary equipment, the overall equipment extraction rate has increased from 92% to 95%, and the fiber damage rate has been further reduced, from the traditional damage rate of 5% to 2%, improving the quality of the cashmere.

YQ-FN150/288 智能分梳联合机

YUAN QUAN MACHINERY Intelligent Combined Carding Production Line

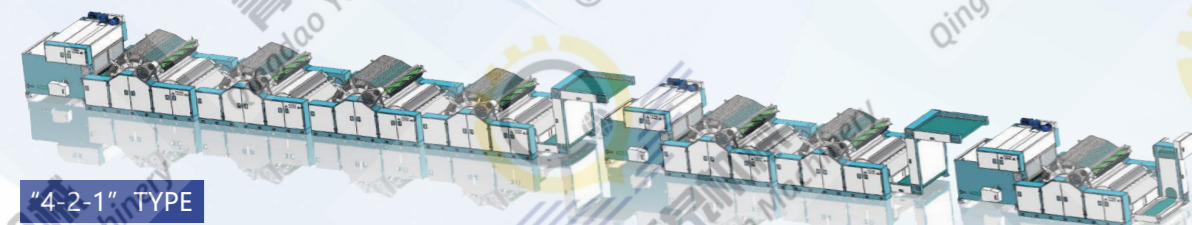

"4-2-1" TYPE

喂料机 + A186 分梳机 (4 台) + 过桥帘 → 喂料机+A186 分梳机 (2 台) +过桥帘 → 喂料机+A186 分梳机 (1 台) +装袋机
Auto Feeder + A186 Dehairing Machine (4 Units) + Cashmere Transfer Bridge → Auto Feeder + A186 Dehairing Machine (2 Units) + Cashmere Transfer Bridge → Auto Feeder + A186 Dehairing Machine (1 Unit) + Dehaired Cashmere Bagging Device

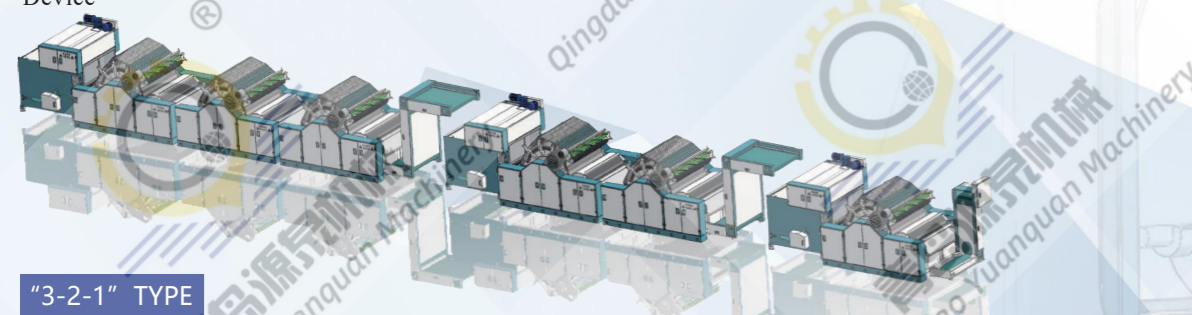

"3-2-1" TYPE

喂料机 + A186 分梳机 (3 台) +过桥帘 → 喂料机+A186 分梳机 (2 台) +过桥帘 → 喂料机+A186 分梳机 (1 台) +装袋机
Auto Feeder + A186 Dehairing Machine (3 Units) + Cashmere Transfer Bridge → Auto Feeder + A186 Dehairing Machine (2 Units) + Cashmere Transfer Bridge → Auto Feeder + A186 Dehairing Machine (1 Unit) + Dehaired Cashmere Bagging Device

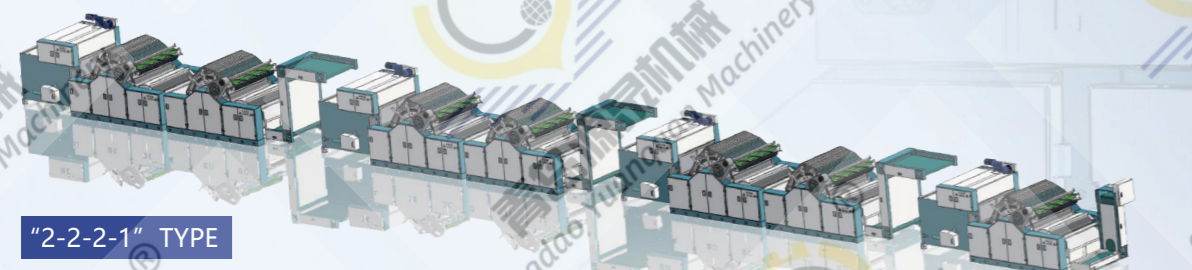

"2-2-2-1" TYPE

喂料机 + A186 分梳机 (2 台) +过桥帘 → 喂料机 + A186 分梳机 (2 台) +过桥帘 → 喂料机+A186 分梳机 (2 台) +过桥帘 → 喂料机+A186 分梳机 (1 台) +装袋机
Auto Feeder + A186 Dehairing Machine (2 Units) + Cashmere Transfer Bridge → Auto Feeder + A186 Dehairing Machine (2 Units) + Cashmere Transfer Bridge → Auto Feeder + A186 Dehairing Machine (2 Units) + Cashmere Transfer Bridge → Auto Feeder + A186 Dehairing Machine (1 Unit) + Dehaired Cashmere Bagging Device

基于多年的发展和丰富的实践经验,青岛源泉机械有限公司致力于为不同种类的羊绒、羊毛或其他动物纤维提供专业的分梳解决方案。以下几种分梳生产线的排列方式供您参考。

Based on years of development and rich practical experience, Qingdao Yuanyuan Machinery Co., Ltd. is committed to providing the most professional dehairing/carding solutions for different types of cashmere, wool, or other animal fibers. The following arrangement methods for dehairing production lines are for your reference.

产品介绍

PRODUCT INTRODUCTION

本机主要用于梳理山羊绒、绵羊毛、牦牛绒、驼绒、羊驼等动物纤维,通过逐步开松梳理、去粗、去杂、去皮、最后制成标准的无毛绒。

This machine is mainly used for carding cashmere, sheep wool, yak, camel hair, alpaca hair and other animal fibers. By opening, carding and removing coarse wool, impurities, and dander, it can finally get high quality cashmere.

机械细节

Machine Details



YQ-WL10/15 喂料机

Feeding Machine
YUAN QUAN MACHINERY

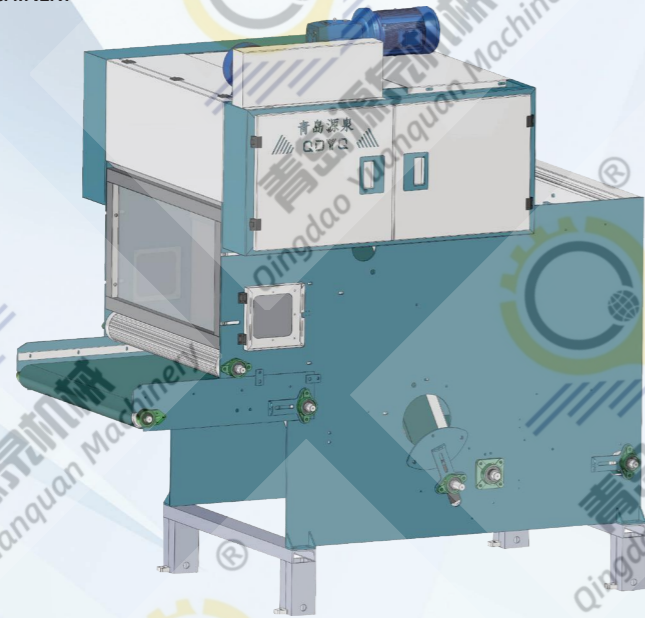

产品介绍

PRODUCT INTRODUCTION

青岛源泉机械有限公司可根据客户的需求,设计制作不同规格的喂料机配合梳理机械使用。
Qingdao Yuanquan Machinery Co.,Ltd could design and produce different specifications of feeding machine according to customers' requirements.

产品特点

PRODUCT CHARACTERISTIC

- 1.本机主要配备各种梳理机械,比如双开松机、梳理机、平梳机等。
 - 2.采用变频调速电机,可控制喂入量,自动调速。
 - 3.喂料机料帘上侧装有强力吸铁装置,螺丝与铁块等能立即吸住。
 - 4.喂料机可初步开松原料,具有和毛、去杂等用处。
 - 5.喂料机机架、零部件采用数控激光切割制作,精度有保障。
 - 6.针帘采用PVC材质、钢针、木棒组成,自固性能好。
- 1.This machine can work with all kinds of carding machine, such as double roller opening machine, cashmere carding machine, flat carding machine and etc.
 - 2.It is equipped with a variable frequency speed-controlling motor, it can automatic control the speed and feeding amount.
 - 3.The upper side of the feeding curtain is equipped with a powerful iron suction device, which can immediately suck screws and iron blocks.
 - 4.The machine can initially open the fibers and has the functions of blending sheep wool and other animal fibers and removing impurities.
 - 5.The frame and parts of feeding machine are produced by CNC laser cutting machine to ensure the precision.
 - 6.The needle curtain is composed of PVC skin board, steel needle and wooden rod, and has good self-fixing performance.

YQ-DCWL10/15 电子称重喂料机

Feeding Machine With Weighting System
YUAN QUAN MACHINERY

- 1.本机可采用整套美国技术进口产品,抗干扰能力和稳定性高。
- 2.逻辑运算及输出控制,采用称为“永久机”的程控电脑。
- 3.加毛提示,周期显示,自调整功能可根据毛仓毛量的多少自动调节喂毛速度减少劳动量。
- 4.本机系统适合国产和进口的各种梳毛机,操作方便,具备基本电气知识者即可管理维护设备。
- 5.储毛挡板及料斗都用气动控制,开闭准确即时。均毛耙与毛帘独立传动,控制灵活。高精度传感器采样,多级称重,多级喂毛速度,可根据毛仓毛量的多少自动调整喂毛速度,并有预喂毛功能。
- 6.人性化的荧光屏和全中文触摸屏,双屏显示,调控一目了然,能翻查若干数据,比如统计数据、周期数据,并有加毛提示功能,界面监控功能,提示运行和报警功能,能直观观察各部分及各阶段的运行状况,且有手动、自动功能,调车方便即时。
- 7.相关指标数据:
 - (1)显示界面:双屏显示(荧光屏、触摸屏)
 - (2)显示精度:1/1000
 - (3)分辨率:±0.1—±1g
 - (4)喂入精度:±2g(正常情况下)
 - (5)去皮范围:0-45000g
 - (6)称重范围:0-999g(或更大)
 - (7)工作环境:温度:-10-45℃,湿度10%-90%,无严重粉尘。

- 1.This machine adopts a complete set of American technology and has high anti-interference ability and stability.
- 2.Logic operation and output control.
- 3.Plus fibers tips, cycle tips, automatic adjustment based on the fibers amount then adjust the speed of feeding, reduce the amount of the labor.
- 4.The machine is suit for domestic and imported carding machines, easy to operate and easy to learn.The workers with basic electrical knowledge can manage and maintain the equipment.
- 5.The fibers baffle and storage hopper are all using pneumatic control, opening and closing accurately. Leveling comb and feeding are driven independently, allowing for flexible control. High-precision sensor sampling, multi-level weighing, multi-level wool feeding speed, which can automatically adjust the wool feeding speed according to the wool volume in the warehouse, and has a pre-feeding function.
- 6.Humanized screen and whole touch screen can easy to see the adjustment and check all the date, such as statistical data, periodic data. There are plus fibers tips and alarm, you can observe the operation of the various parts and stages directly. It also has manual and automatic function, shunting convenient and instant.
- 7.Related indicator data:
 - (1)Display Interface: Dual Display (Phosphor Screen, Touch Screen)
 - (2)Display accuracy: 1/10000
 - (3)Resolution: ±0.1—±1g
 - (4)Feeding accuracy: ±2g (Under normal circumstances)
 - (5)The Range of Removing Dander: 0-45000g
 - (6)Weighing range: 0-999g (or more)
 - (7)Working condition: Temperature: -10~45℃,humidity: 10%-90%, no serious dust.

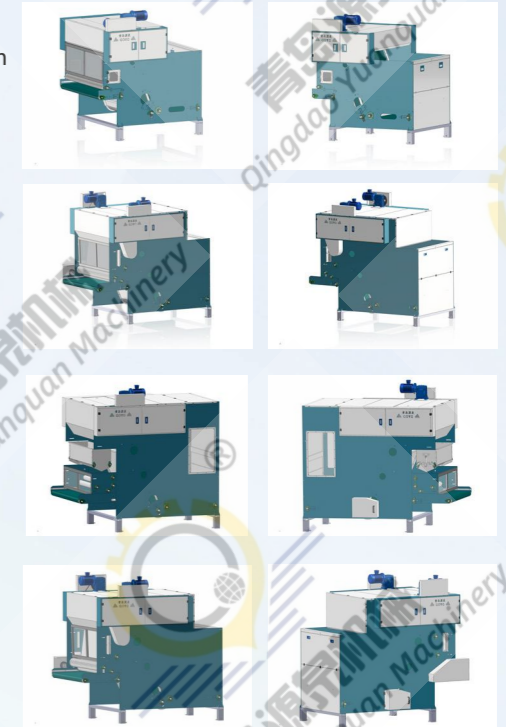

产品可根据客户需求定制
Products can be customized according to customer needs



YQ-A186 分梳机

YUAN QUAN MACHINERY Dehairing Machine

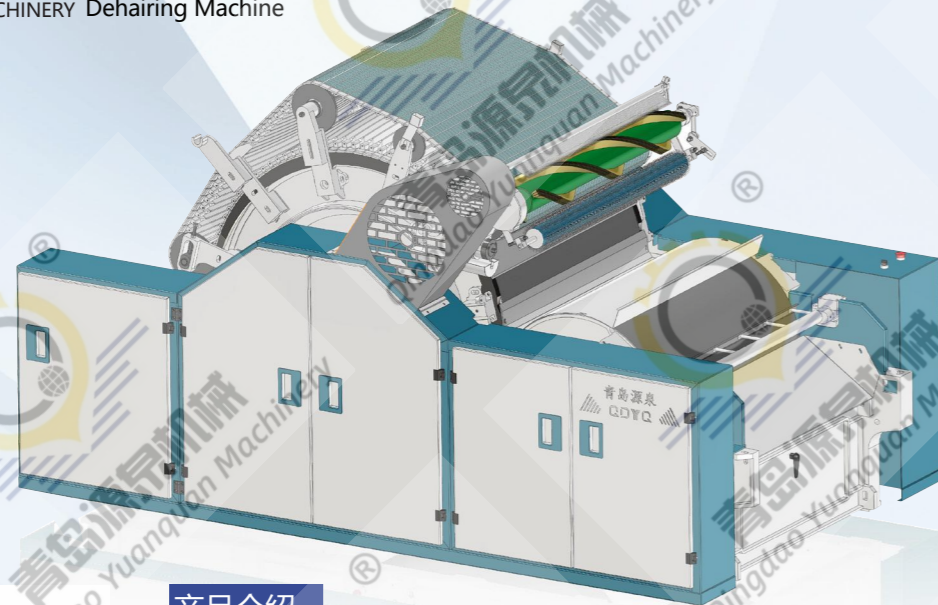

产品介绍

PRODUCT INTRODUCTION

本机主要梳理山羊绒、绵羊绒、牦牛绒、驼绒等动物纤维原料。本机开松梳理去粗、去杂、去皮，可多机结合梳理，是联合梳理机必备产品。

This machine is mainly used for carding cashmere, sheep wool, yak hair, camel hair and other animal fibers. It opens and combs to remove coarse wool, impurities and dander. It can be connected with multiple machines for carding, which is an essential product for carding production line.

机械细节

Machine Details



主要规格及参数

MAIN SPECIFICATIONS AND PARAMETERS

| 型号 Model | 工作幅宽 Working Width mm | 外形尺寸 Dimension L×W×H(mm) | | | 重量 Wt kg | 功率 Power kw | 部件运转 Main Parts | | | 产量 Output kg/h |
|-------------|-----------------------------|--------------------------------|------|------|----------------|-------------------|--------------------|----------------|--------------|----------------------|
| | | | | | | | 刺辊 Licker-in | 锡林 Cylinder | 道夫 Doffer | |
| | | | | | | | r/min | | | |
| YQ-A186 | 1020 | 3080 | 1830 | 1730 | About 4100 | 2.8 | 500-600 | 180-210 | 10-12 | 5-10 |
| YQ-FS15 | 1500 | 3080 | 2330 | 1730 | About 5800 | 2.8 | 500-600 | 180-210 | 10-12 | 6-15 |

YQ-PS10/15 羊绒平梳机

YUAN QUAN MACHINERY Flat Carding Machine

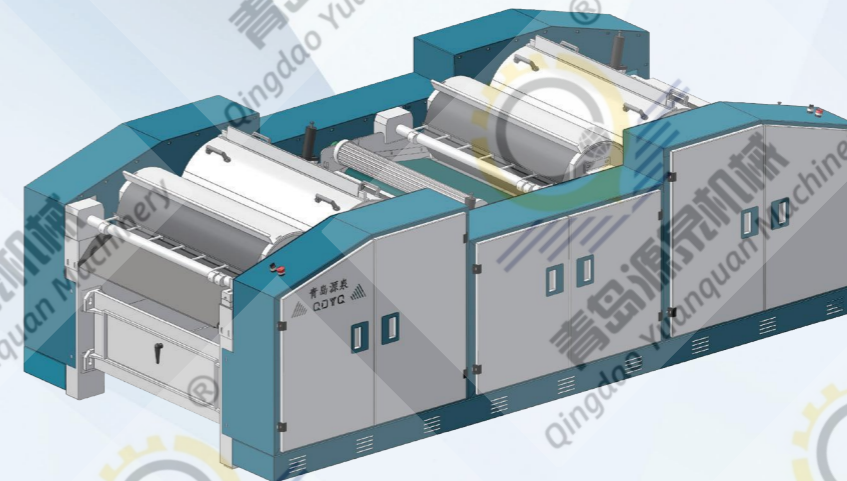

产品介绍

PRODUCT INTRODUCTION

本机主要对山羊绒、绵羊绒、牦牛绒、驼绒、羊驼毛等动物纤维进行开松、梳理。采用双给棉板、双刺辊、双锡林、双道夫的梳理排列，节省设备摆放空间，使其去粗、去杂、去皮屑的效果最大化，是分梳生产线中必备产品之一。

This machine is mainly used for carding cashmere, sheep wool, camel hair, yak hair and other animal fibers. It adopts double feeding boards, double licker-in rollers, double cylinders and double doffers, which saves the space of equipment and achieves the maximization effect of removing coarse, impurities and dander. It is the essential product of cashmere carding production line.

机械细节

Machine Details

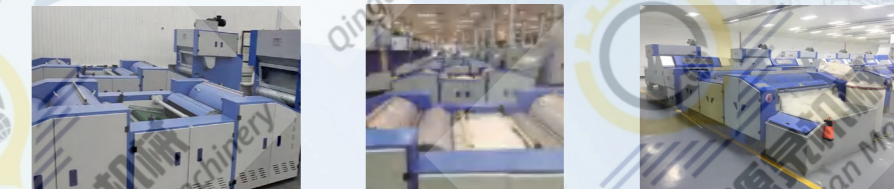

主要规格及参数

MAIN SPECIFICATIONS AND PARAMETERS

| 型号 Model | 工作幅宽 Working Width mm | 外形尺寸 Dimension L×W×H(mm) | | | 重量 Wt kg | 功率 Power kw | 台时产量 Output kg/h | 喂入方式 Feeding Way / | 车别 Machine Type / |
|-------------|-----------------------------|--------------------------------|------|------|----------------|-------------------|------------------------|--------------------------|-------------------------|
| | | | | | | | | | |
| YQ-PS10 | 1020 | 3500 | 1900 | 1150 | About 2100 | 3.3 | 5-10 | 喂毛机 Feeding Machine | 右手车 Right Hand |
| YQ-PS15 | 1500 | 3500 | 2400 | 1150 | About 3000 | 3.3 | 7-15 | | |

YQ-DKS10/15 单开松机

YUAN QUAN MACHINERY Single Cylinder Opening Machine

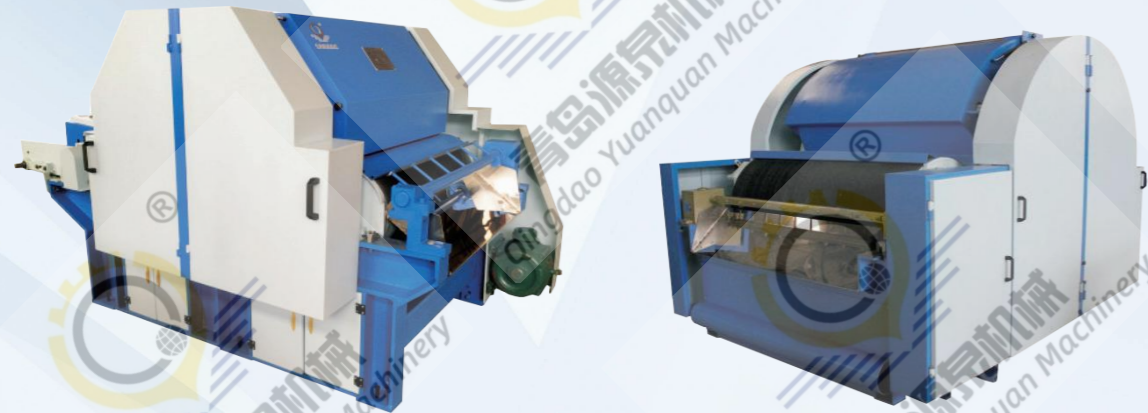

产品介绍

PRODUCT INTRODUCTION

本机主要开松羊毛、绵羊毛、驼绒、牦牛绒，羊驼等动物纤维。经过上料，逐步开松、去粗、去杂、去皮梳理，斩刀剥取供下道工序使用经过开松梳理后，原料显蓬松状态。

This machine is mainly used for carding sheep wool, camel hair, yak hair, cashmere and other animal fibers. After feeding and opening, it can remove impurities, dander. The chopping knife stripped for application of next working procedure, after carding, the fibers were fluffy state.

机械细节

Machine Details

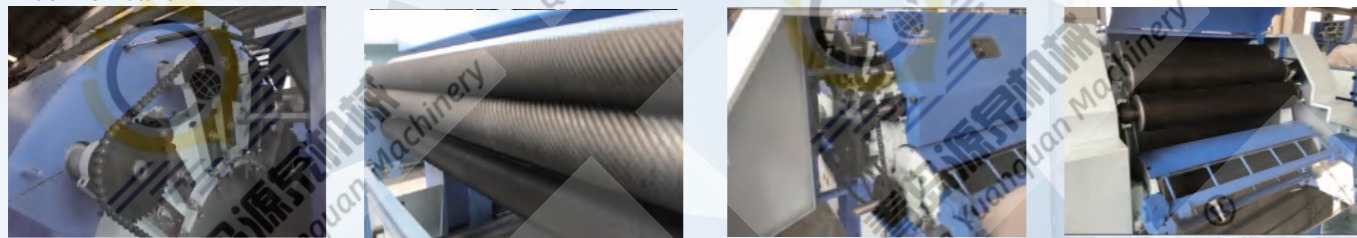

主要规格及参数

MAIN SPECIFICATIONS AND PARAMETERS

| 型号 Model | 工作幅宽 Working Width | 外形尺寸 Dimension | | | 重量 Wt | 拖动功率 Power | 台时产量 Output | 喂入方式 Feeding Way | 车别 Machine Type |
|-------------|-----------------------|-------------------|------|------|------------|---------------|----------------|------------------------|--------------------|
| | mm | L×W×H(mm) | | | kg | kw | kg/h | / | / |
| YQ-DKS10 | 1020 | 2500 | 1950 | 1550 | About 2500 | 1.5 | 10-20 | 喂毛机 Feeding Machine | 右手车 Right Hand |
| YQ-DKS15 | 1500 | 2700 | 2450 | 1950 | About 4200 | 2.8 | 30-40 | | |

YQ-XY30/36/50 小样机

YUAN QUAN MACHINERY Small Carding Machine

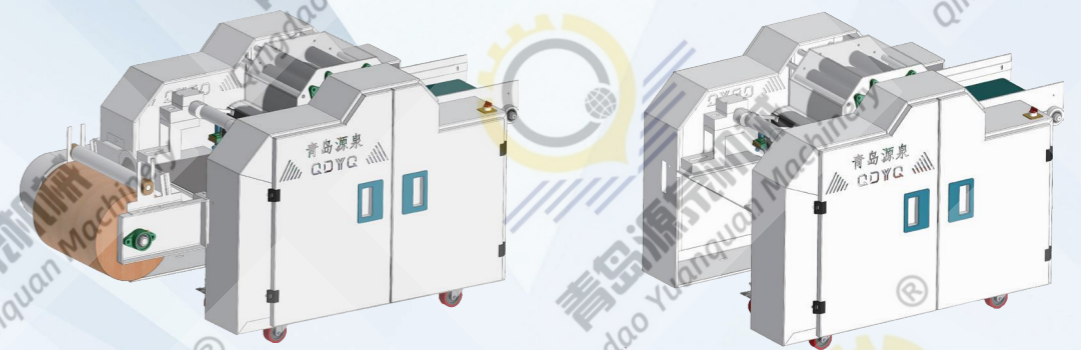

产品介绍

PRODUCT INTRODUCTION

本机适用于羊毛、羊绒、驼绒、牦牛绒等动物纤维，斩刀剥取或圈条器出条。This machine is suitable for animal fibers such as wool, cashmere, camel hair, yak hair, etc. The fiber web after carding can be stripped with a chopper or rolled out with a coiler.

1. 本机机幅小、相对轻便，底部带万向滑轮运输方便。
2. 本机梳理样品时，上料少，快捷方便
3. 本机根据客户需求，可做220v或380v两种电压。

1. This machine is small in size and easy to take. And the bottom is equipped with universal pulleys for easy transportation.
2. When testing sample, it easy to operate.
3. The voltage can be 220v/380v according to customers' requirements.

机械细节

Machine Details

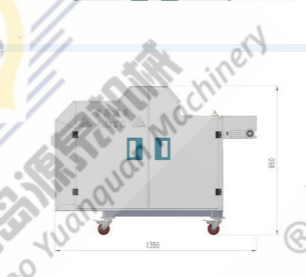

主要规格及参数

MAIN SPECIFICATIONS AND PARAMETERS

| 型号 Model | 工作幅宽 Working Width | 外形尺寸 Dimension | | | 重量 Wt | 功率 Power | 产量 Output | 部件转速 Working Speed of Parts | | |
|-------------|-----------------------|-------------------|------|-----|-----------|-------------|--------------|--------------------------------|-------|------|
| | | L×W×H(mm) | | | | | | kg | kw | kg/h |
| | | | | | | | r/min | | | |
| YQ-XY30 | 300 | 1350 | 900 | 950 | About 350 | 0.75 | 1-4 | 85 | 10-12 | 28 |
| YQ-XY36 | 360 | 1350 | 960 | 950 | About 450 | 0.75 | 1-4 | 85 | 10-12 | 28 |
| YQ-XY50 | 500 | 1350 | 1350 | 950 | About 550 | 0.75 | 1-4 | 85 | 10-12 | 28 |

YQ-SKS10/15 双开松机

YUAN QUAN MACHINERY Double Roller Opening Machine

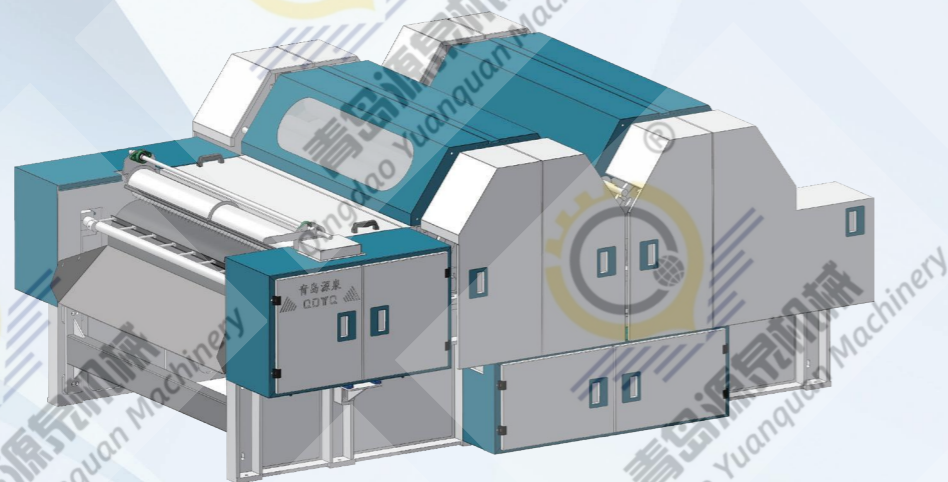

产品介绍

PRODUCT INTRODUCTION

本机开松由双锡林排列，一辊筒软开，二辊筒精开。工作辊与拔毛辊结合锡林滚筒可达到开松梳理出单纤维且蓬松状态的动物纤维。后辊筒部分有去粗、去杂效果；分梳行业为最前道工序，效果突出，是联合梳理机必备产品之一。

This machine use double cylinder arrangement, one for preliminary opening, and other for fine opening. Working roller with stripping roller combined with cylinder can open and card out single fiber and fluffy animal fibers. And the fine roller have the effect of removing the coarse hair and impurities it is the first process in carding industry. With outstanding effect, it is an essential product of carding production line.

机械细节

Machine Details



主要规格及参数

MAIN SPECIFICATIONS AND PARAMETERS

| 型号 Model | 工作幅宽 Working Width | 外形尺寸 Dimension | | | 重量 Wt | 功率 Power | 台时产量 Output | 喂入方式 Feeding Way | 车别 Machine Type |
|-------------|-----------------------|-------------------|------|------|------------|-------------|----------------|------------------------|--------------------|
| | mm | L | W | H | kg | kw | kg/h | / | / |
| YQ-SKS10 | 1020 | 3290 | 2400 | 1450 | About 3200 | 3.35 | 7-12 | 喂毛机 Feeding Machine | 右手车 Right Hand |
| YQ-SKS15 | 1500 | 3290 | 2900 | 1450 | About 4300 | 3.35 | 10-15 | | |

YQ-LLC10/15 双开松罗拉车

YUAN QUAN MACHINERY Double Roller Opening Machine

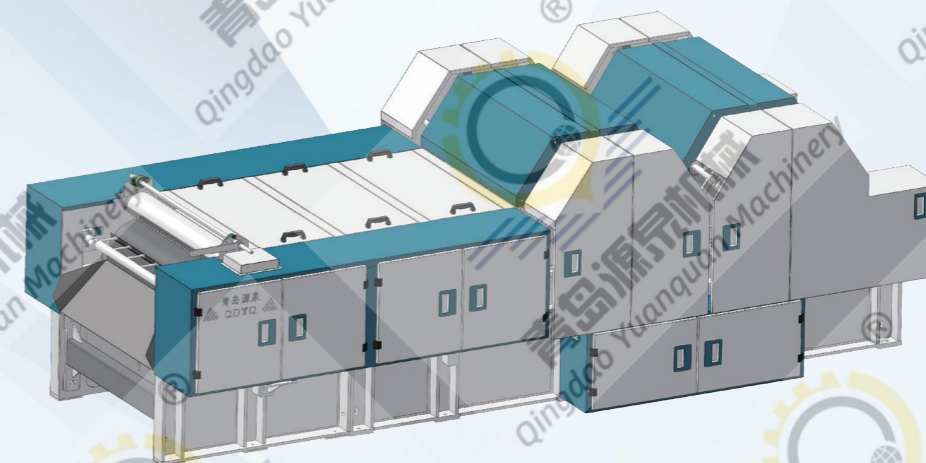

产品介绍

PRODUCT INTRODUCTION

本机适用于洗净羊毛、羊绒、驼绒、牦牛绒等动物纤维。经过均匀上料逐步开松、去粗、去杂、梳理，斩刀剥取供下一道工序使用。

This machine is suitable for washed clean sheep wool, cashmere, camel hair, yak hair and other animal fibers. After uniform feeding and opening step by step, it can remove the coarse wool, impurities, dander, then the fibers can be stripped by chopping knife for the next procedure.

机械细节

Machine Details



主要规格及参数

MAIN SPECIFICATIONS AND PARAMETERS

| 型号 Model | 工作幅宽 Working Width | 外形尺寸 Dimension | | | 重量 Wt | 拖动功率 Power | 台时产量 Output | 喂入方式 Feeding Way | 车别 Machine Type |
|-------------|-----------------------|-------------------|------|------|------------|---------------|----------------|------------------------|--------------------|
| | mm | L | W | H | kg | kw | kg/h | / | / |
| YQ-LLC10 | 1020 | 4410 | 1950 | 1450 | About 4500 | 3.35 | 5-12 | 喂毛机 Feeding Machine | 右手车 Right Hand |
| YQ-LLC15 | 1500 | 4410 | 2500 | 1550 | About 5800 | 3.35 | 8-15 | | |

YQ-DKS15 新型大开松机

YUAN QUAN MACHINERY New Type Double Roller Opening Machine

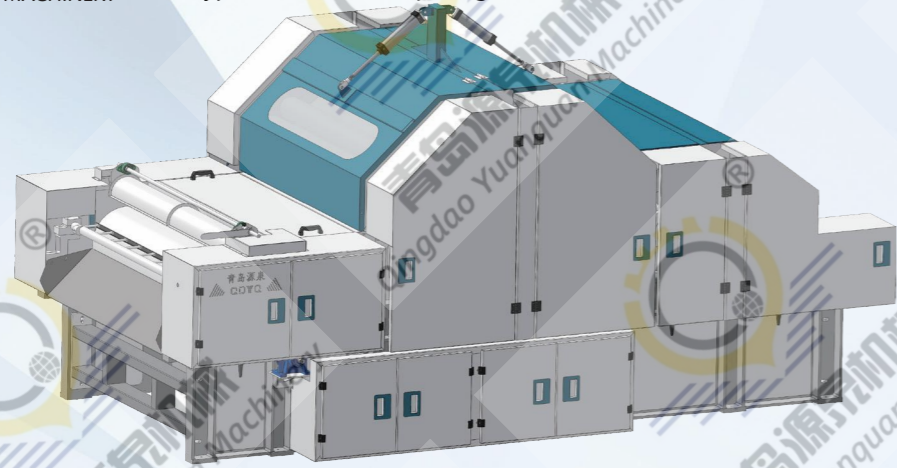

产品介绍

PRODUCT INTRODUCTION

本机主要开松、梳理山羊绒、绵羊绒、牦牛绒、驼绒等动物纤维。经过逐级开松、梳理、去粗、去杂，使原料达到单纤维状态供后道梳理工序使用。本机具有开松效果好、下机产量高、纤维损伤率低的优点，是羊绒分梳联合机中的优选设备之一。

This machine is mainly used to open and card animal fibers, such as cashmere, sheep wool, yak hair, camel hair, etc. After opening, carding, and impurity removal, the fibers can reach the single fiber web for using in the subsequent carding process. This machine has the advantages of good opening effect, high output and low fiber damage rate. It is one of the preferred equipment in cashmere carding combined machines.

机械细节

Machine Details

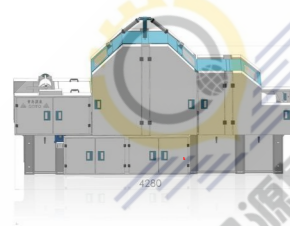
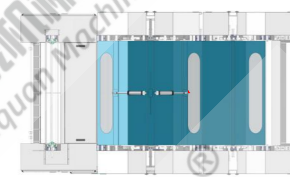
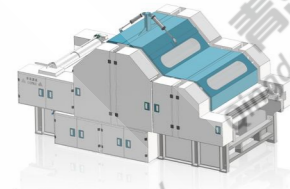

主要规格及参数

MAIN SPECIFICATIONS AND PARAMETERS

| 型号 Model | 工作幅宽 Working Width | 外形尺寸 Dimension | | | 重量 Wt | 拖动功率 Power | 台时产量 Output | 喂入方式 Feeding Way |
|-------------|-----------------------|-------------------|------|------|------------|---------------|----------------|------------------------|
| | mm | L×W×H(mm) | | | kg | kw | kg/h | |
| YQ-DKS15 | 1500 | 4280 | 2400 | 1950 | About 5300 | 6.55 | 25 | 喂毛机 Feeding Machine |

YQ-ZT10 半精纺制条机

YUAN QUAN MACHINERY Semi-Worsted Carding Machine

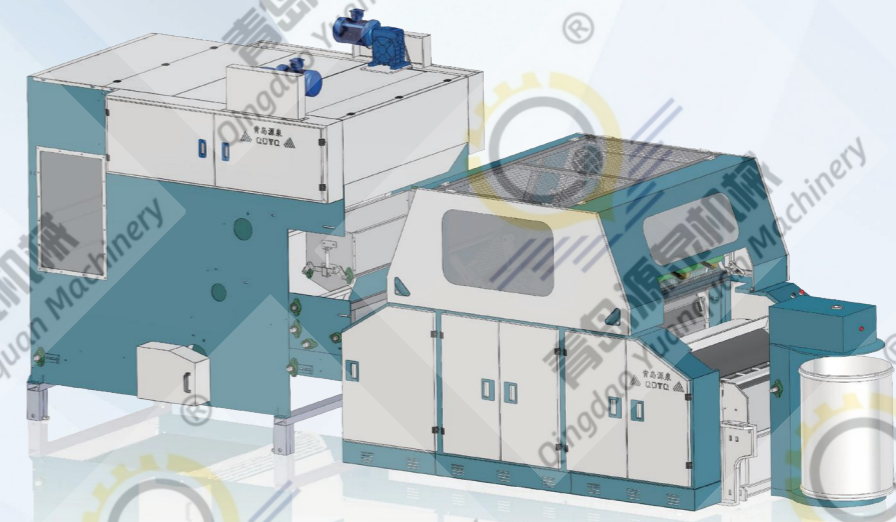

产品介绍

PRODUCT INTRODUCTION

本机主要适用于山羊绒、兔绒、牦牛绒、蚕丝、化纤等散纤维，适纺纤维长度为16-80mm。将电子称重喂毛机均匀送来的纤维层进行开松和梳理，使所有呈卷曲、块状的纤维理成基本伸直的单纤维状态，后经剥网圈条供后道工序使用。

This machine is mainly suitable for cashmere, rabbit hair, yak hair, silk, chemical fiber and other loose fibers. The suitable fiber length is 16-80mm. The machine open and card the fiber layer transferred by electronic weighing feeder, making all the curly, block fiber into straight single fiber, and then stripped and coiled for subsequent processes.

机械细节

Machine Details



主要规格及参数

MAIN SPECIFICATIONS AND PARAMETERS

| 型号 Model | 工作幅宽 Working Width | 外形尺寸 Dimension | | | 重量 Wt | | 功率 Power | | 产量 Output |
|-------------|-----------------------|-------------------|------|------|--------------------------|--------------------------|----------------------|--------------|--------------|
| | | | | | 梳理 Carding Machine | 毛斗 Feeding Machine | 主电机 Main Motor | 道夫 Doffer | |
| | mm | L×W×H(mm) | | | kg | | kw | | kg/h |
| YQ-BJF10 | 1020 | 3300 | 2000 | 1800 | About 4000 | About 1500 | 3.3 | 1.5 | 5-20 |

YQ-ZT15 羊绒制条机

YUAN QUAN MACHINERY Cashmere Slivering Machine

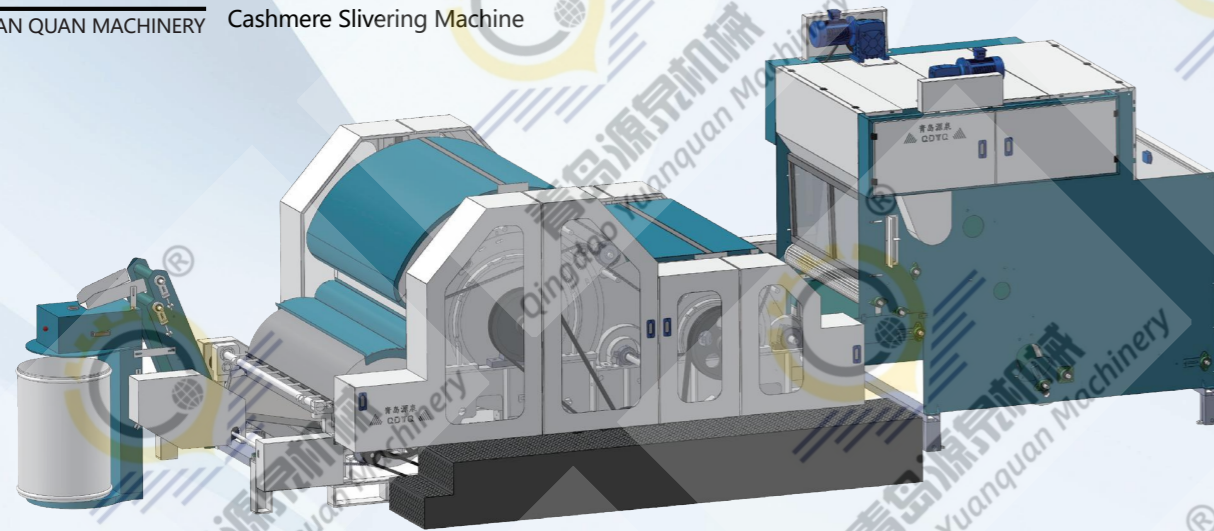

产品介绍

PRODUCT INTRODUCTION

本机主要适用于羊绒、牦牛绒、驼绒等动物纤维，其主要用于将分梳后的无毛绒梳理加工成羊绒条。结合电子称重喂料机使用，可以确保喂入量的均匀度和精度，从而保证生产出的羊绒条粗细、克重均匀。

This machine is mainly suitable for cashmere, yak hair, camel hair and other animal fibers. It is mainly used to card and process the standard dehaired fiber after carding into cashmere sliver. Connected with an electronic weighing feeder, the uniformity and accuracy of the feeding amount can be ensured, which ensures the thickness and weight of the cashmere sliver.

机械细节

Machine Details

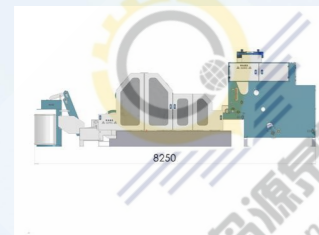

主要规格及参数

MAIN SPECIFICATIONS AND PARAMETERS

| 型号 Model | 工作幅宽 Working Width mm | 外形尺寸 Dimension L×W×H(mm) | | | 重量 Wt | | 功率 Power | | 喂入产量 Feeding Quantity kg/h | 出条速度 Speed of Making Sliver m/min |
|-------------|-----------------------------|--------------------------------|------|------|-----------------------|------------------------|-------------------|-----------------------|----------------------------------|---|
| | | | | | 梳理 Carding Machine | 喂毛机 Feeding Machine | 主电机 Main Motor | 喂毛 Feeding Machine | | |
| | | | | | kg | kg | kw | kw | | |
| YQ-ZT15 | 1550 | 8250 | 3550 | 2050 | About 6500 | About 1500 | 5.8 | 2.6 | 15-25 | 25-50 |

YQ-GZT15 高速制条机

YUAN QUAN MACHINERY High Speed Slivering Machine

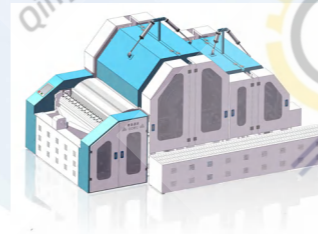
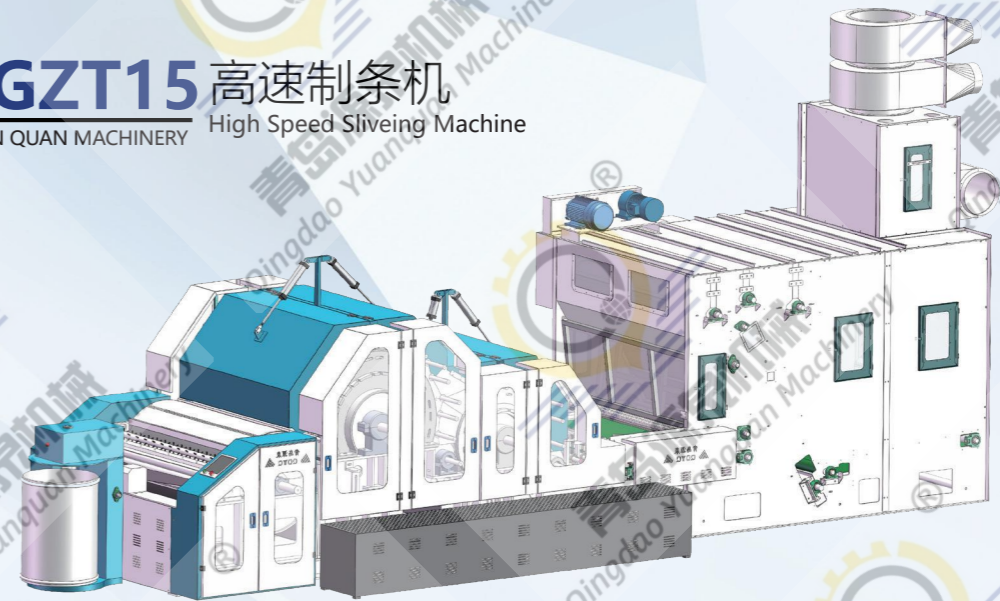

产品介绍

PRODUCT INTRODUCTION

该机速度快、容量大，适用于化纤及混纺纤维的开松、梳理混纺，将纤维制成所需规格的纤维条，然后定期卷绕成条筒供下道工序使用。

This machine with high speed and capacity is applicable to open, card and mix chemical fibers. It can make the fibers into fiber sliver with required specifications, and then coil them into sliver regularly for the next process.

机械细节

Machine Details

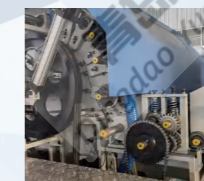
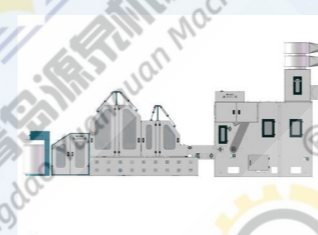

主要规格及参数

MAIN SPECIFICATIONS AND PARAMETERS

| 型号 Model | 工作幅宽 Working Width mm | 外形尺寸 Dimension L×W×H(mm) | | | 重量 Weight kg | 总功率 Total Power kw | 台时产量 Output kg/h | 毛条重量 Sliver Size g/m | 条筒直径 Sliver Can Diameter mm |
|-------------|-----------------------------|--------------------------------|------|------|--------------------|--------------------------|------------------------|----------------------------|-----------------------------------|
| | | | | | | | | | |
| YQ-GZT15 | 1550 | 4500 | 3550 | 2050 | About 12000 | 24 | 80 | 7-20 | 1200 |

YQ-LGT12 六滚筒开毛机

YUAN QUAN MACHINERY Step Cleaner

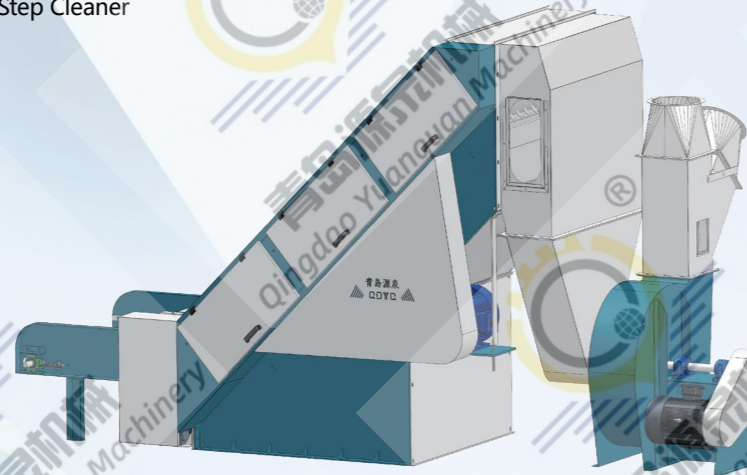

产品介绍

PRODUCT INTRODUCTION

六滚筒开毛机主要开松原绒：山羊绒、绵羊毛、牦牛绒、驼绒等动物纤维。本机开松辊采用斜式排列，充分利用离心力，是去粗、去杂、去皮的最佳效果。结合风机吸风均匀落入和毛仓，是梳理前配备的必要产品。

This machine is mainly used for opening all kinds of woolen: sheep wool, yak hair, camel hair and other animal fibers. The working roller is oblique, making full use of centrifugal force, which can remove the dirt and impurities and dander. It combined with suction fans evenly falling into mixing box and it is essential product before carding.

机械细节

Machine Details



主要规格及参数

MAIN SPECIFICATIONS AND PARAMETERS

| 型号 Model | 工作幅宽 Working Width | 外形尺寸 Dimension | | | 重量 Wt | 风机功率 Fan Power | 产量 Output | 喂入罗拉 Feeding Roller | 打毛辊 Fiber Opening Roller |
|-------------|-----------------------|-------------------|------|------|------------|-------------------|--------------|------------------------|-----------------------------|
| | mm | L×W×H(mm) | | | kg | kw | kg/h | / | / |
| YQ-LGT12 | 1200 | 3800 | 1600 | 2500 | About 3000 | 5.5-7.5 | 3-6 | A group | 6 groups |

YQ-DZL 单轴流

YUAN QUAN MACHINERY Dandruff Removing Machine

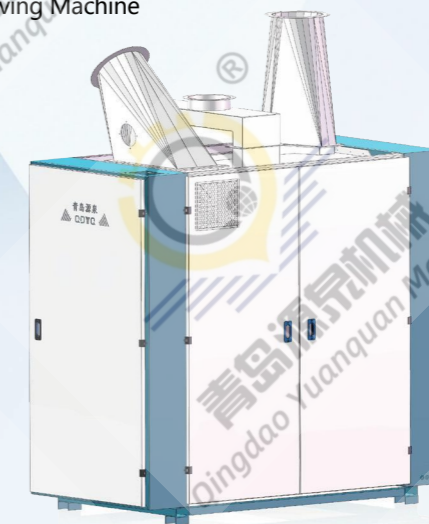

产品介绍

PRODUCT INTRODUCTION

本机主要适用于加工动物纤维、化学纤维和混合原料。进入本机的原料在自由状态下经过均匀、密集、柔和的弹打，原料得到充分的开松除杂，并有效的保护纤维，避免损伤。

This machine is suitable for animal fibers, chemical fibers and blended fibers. The fibers inside this machine are opened sufficiently after repetitive, flexible and gentle beat. During opening, impurities are separated from the fibers. The fibers are opened and purified then transported to the next process. It protects fiber from damage.

机械细节

Machine Details



主要规格及参数

MAIN SPECIFICATIONS AND PARAMETERS

| 型号 Model | 工作幅宽 Working Width | 外形尺寸 Dimension | | | 装机功率 Installed Power | 产量 Output | 重量 Weight | 角钉打手直径 Beater Diameter | 角钉打手 Beater |
|-------------|-----------------------|-------------------|------|------|-------------------------|--------------|--------------|---------------------------|---|
| | mm | L×W×H(mm) | | | kw | kg/h | kg | mm | / |
| YQ-DZL | 1200 | 2260 | 1150 | 1950 | 11 | 500 | About 1500 | Φ750 | 皮带轮或变频调速 Control by Pulley or Inverter |

YQ-B261 和毛机

YUAN QUAN MACHINERY Fiber Mixing Machine



产品介绍

PRODUCT INTRODUCTION

本机将各类洗净毛、绒或植物纤维、进行初步开松、混合除杂、并加入适量乳化油剂(和毛油),使纤维松散,混合均匀,增加其柔软性、润滑性、消除和减少静电,供下道工序梳毛和制条使用。

This machine could open all kinds of cleaned wool, velvet, plant fibers and remove the debris. Adding proper amount of emulsified oil (wool oil) to make the fiber fluffy and mixed evenly to increase its softness and lubrication, which can eliminate and reduce static electricity for next carding and spinning.

机械细节

Machine Details



主要规格及参数

MAIN SPECIFICATIONS AND PARAMETERS

| 型号 Model | 工作幅宽 Working Width mm | 外形尺寸 Dimension L×W×H(mm) | | | 重量 Wt kg | 产量 Output kg/h | 功率 Power | | | 部件转速 Parts of Speed | |
|-------------|-----------------------------|--------------------------------|------|------|----------------|----------------------|-------------------|-----------|--------------------------|------------------------|--------------|
| | | | | | | | 主电机 Main Motor | 风机 Fan | 加油装置 Refueling Device | 锡林 Cylinder | 道夫 Doffer |
| | | | | | | | | | | | |
| YQ-B261 | 900 | 2315 | 1650 | 1250 | About 2000 | 400-600 | 5.5 | 4 | 1.1 | 347 | 834 |

YQ-B262 和毛机

YUAN QUAN MACHINERY Fiber Mixing Machine

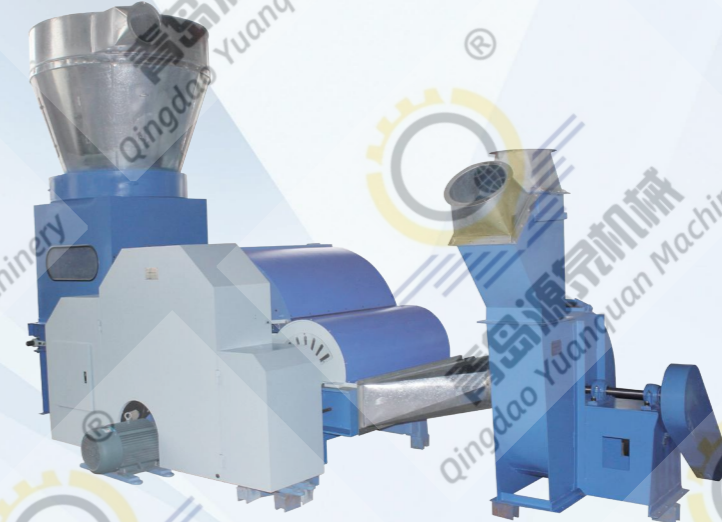

产品介绍

PRODUCT INTRODUCTION

该机器的工作原理与B261和毛机的基本相同,其产量大于B261。一般来说,B262和毛机主要使用我们的半精仿梳棉机或羊绒制条机。当进行混纺时(例如70%的羊毛和30%的涤纶纤维),B262和毛机可以通过各个工作辊的配合将两种或两种以上的纤维混合,从而满足混纺的要求供下道工序使用。

The working principle of this machine is basically the same as that of the B261 fiber mixing machine, and its output is larger than B261. Generally speaking, it is mainly working with semi-worsted carding machine or cashmere slivering machine. When mixing (for example, 70% wool and 30% polyester fiber), the B262 fiber mixing machine can mix two or more fibers through the cooperation of each working roller to meet the blending requirements for the next process.

机械细节

Machine Details

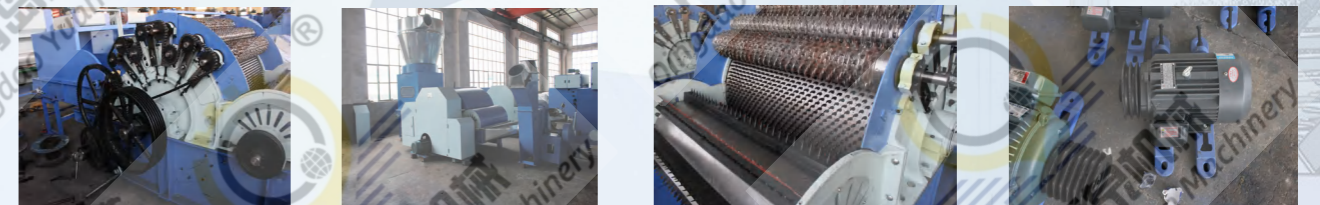

主要规格及参数

MAIN SPECIFICATIONS AND PARAMETERS

| 型号 Model | 工作幅宽 Working Width mm | 外形尺寸 Dimension L×W×H(mm) | | | 重量 Wt kg | 产量 Output kg/h | 功率 Power | | | 部件转速 Parts of Speed | |
|-------------|-----------------------------|--------------------------------|------|------|----------------|----------------------|-------------------|-----------|--------------------------|------------------------|--------------|
| | | | | | | | 主电机 Main Motor | 风机 Fan | 加油装置 Refueling Device | 锡林 Cylinder | 道夫 Doffer |
| | | | | | | | | | | | |
| YQ-B262 | 1200 | 3920 | 2610 | 1550 | About 5500 | 800-1000 | 7.5 | 5.5 | 1.1 | 210 | 880 |

YQ-DHS10/15 单落物回收机

YUAN QUAN MACHINERY Single Group Droppings Reclaiming Machine

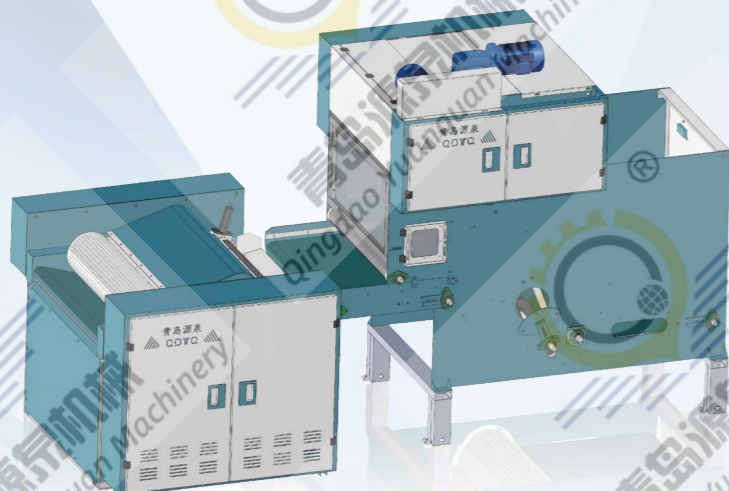

产品介绍

PRODUCT INTRODUCTION

本机主要高效提取山羊绒、驼绒、牦牛绒等落物料，去粗去杂，提取长度在15mm以下的短绒。

This machine is mainly used to efficiently extract carded cashmere, camel hair, yak hair and other fibers. It can also remove coarse wool and impurities, and extract short woolen below the 15mm.

机械细节

Machine Details



主要规格及参数

MAIN SPECIFICATIONS AND PARAMETERS

| 型号 Model | 工作幅宽 Working Width mm | 外形尺寸 Dimension L×W×H(mm) | | | 重量 Wt kg | 功率 Power | | 喂入量 Input kg/h |
|-------------|-----------------------------|--------------------------------|------|------|----------------|-------------------|---------------|----------------------|
| | | | | | | 主电机 Main Motor | 喂入 Feeding | |
| | | kw | kw | | | | | |
| YQ-DHS10 | 1020 | 3700 | 1850 | 2250 | About 1000 | 1.5 | 0.55 | 8-10 |
| YQ-DHS15 | 1500 | 3700 | 2450 | 2250 | About 1500 | 1.5 | 0.55 | 10-15 |

YQ-SHS10/15 双落物回收机

YUAN QUAN MACHINERY Double Groups Droppings Reclaiming Machine

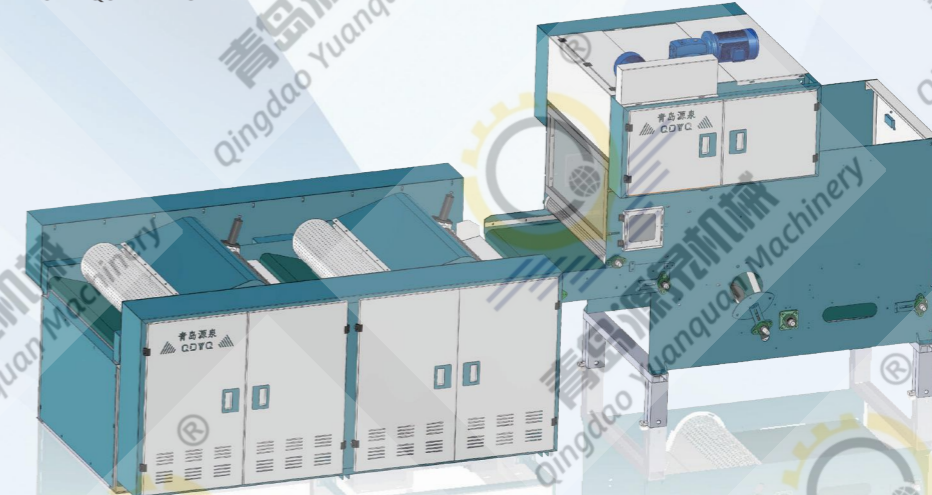

产品介绍

PRODUCT INTRODUCTION

本机采用双组排列节省使用空间，提取率高，降低劳动强度，提高生产效率。

This machine adopts two groups of arrangement to save space, and it has high extraction rate and reduces labor intensity and improves production efficiency.

机械细节

Machine Details



主要规格及参数

MAIN SPECIFICATIONS AND PARAMETERS

| 型号 Model | 工作幅宽 Working Width mm | 外形尺寸 Dimension L×W×H(mm) | | | 重量 Wt kg | 功率 Power kw | 产量 Output kg/h | 车别 |
|-------------|-----------------------------|--------------------------------|------|------|----------------|-------------------|----------------------|-------------------|
| | | | | | | | | Machine Type |
| | | / | | | | | | |
| YQ-SHS10 | 1020 | 5000 | 1850 | 2250 | About 1500 | 2.35 | 7-10 | 右手车 Right Hand |
| YQ-SHS15 | 1500 | 5000 | 2450 | 2250 | About 2000 | 2.35 | 10-15 | |

YQ-CL05/08 吸风尘笼

YUAN QUAN MACHINERY Suction Condenser

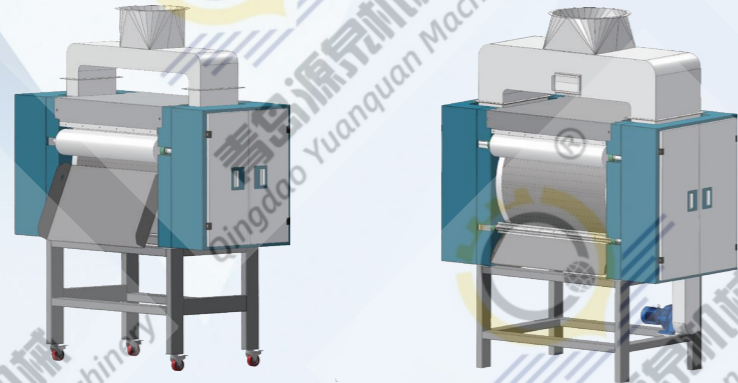

产品介绍

PRODUCT INTRODUCTION

1. 本产品将羊绒生产线上甩下的落物通过负压吸风统一回收到指定位置，避免了人工掏毛所造成的人工成本。
2. 将开松下的原料通过负压吸风方式自动喂入平梳机，降低了人工，节省了车间空间，提高了车间内部地面与设备的整洁度，是负压全自动羊绒分梳线的必要产品。

1. This machine collects the fallen cashmere thrown off the cashmere production line to the designated location through negative pressure suction, avoiding the labor cost caused by manual wool removal.

2. This machine will automatic feed the fibers to flat carding machine by negative pressure suction mode, which reduces labor and saves space of workshop and improves the cleanliness of workshop ground and equipment. It is also a necessary product for the negative pressure full automatic cashmere carding production line.

机械细节

Machine Details

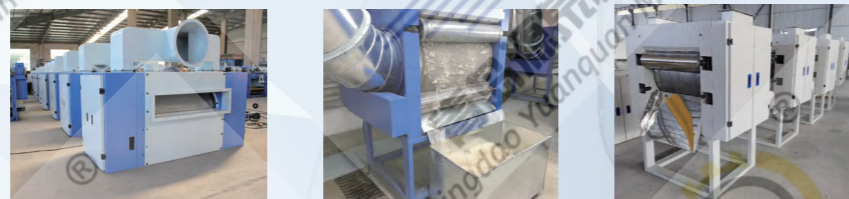

其它配件 OTHER ACCESSORIES

Transfer Bridge
过桥帘



Bagging Device
装袋机

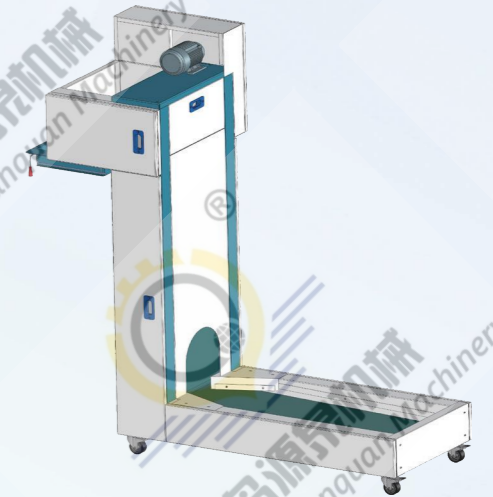

Metal Card Clothing Wrapping Machine
金属针布包卷机

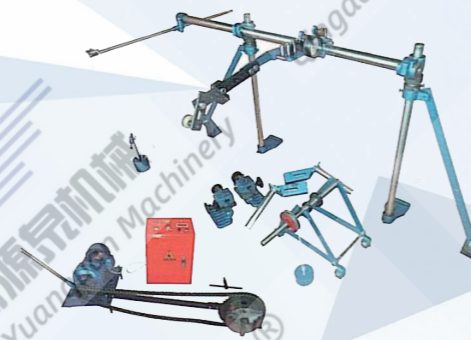

Metal Function Card Clothing Welder
金属针布焊接机



Wrapping Flat Clothing Machine
磨盖板针布机



Wrapping Flat Clothing Machine
包盖板针布机

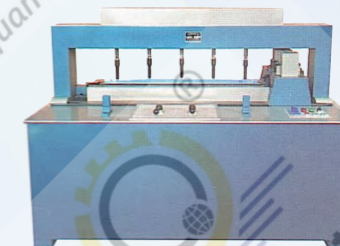

Licker-in Roller Wrapping And Grinding Machine
刺辊包磨机

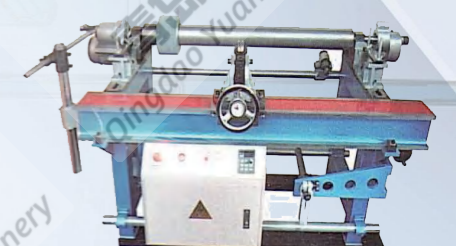

主要规格及参数

MAIN SPECIFICATIONS AND PARAMETERS

| 型号 Model | 尘笼直径 Diameter | 工作幅宽 Working Width | 外形尺寸 Dimension | | | 重量 Wt | 功率 Power | 产量 Output |
|-------------|------------------|-----------------------|-------------------|------|------|-----------|-------------|--------------|
| | mm | mm | L×W×H(mm) | | | kg | kw | kg/h |
| YQ-CL05 | 500 | 980 | 1850 | 800 | 2200 | About 500 | 0.55 | 10-25 |
| YQ-CL08 | 800 | 980 | 1900 | 1100 | 2450 | About 600 | 0.55 | 10-35 |

YQ-272 272系列粗纺梳毛机

YUAN QUAN MACHINERY 272 Series Woolen Carding Spinning Machine

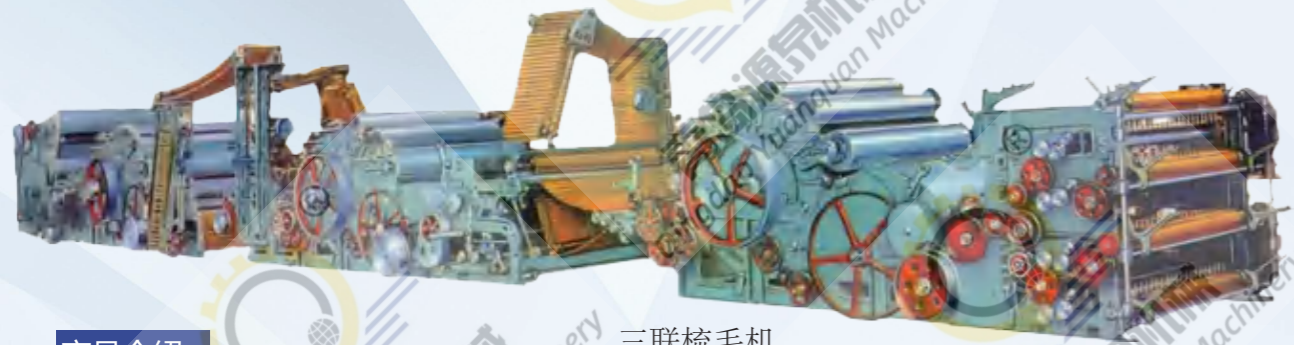

产品介绍

PRODUCT INTRODUCTION

本机用于对已开松、加油混合后的羊毛等动物纤维进行除杂混合及分条等工艺，此过程制成具有一定重量的粗纱。

This machine is designed for the opened, oiled and blended wool to carry out trash-extraction, blending and slivering processes and produce wool tops of given counts.

三联梳毛机
Triple-Component



四联梳毛机
Quadri-Component

二联梳毛机
Dual-Component

机械细节

Machine Details



主要规格及参数

MAIN SPECIFICATIONS AND PARAMETERS

| 型号 Model | 工作幅宽 Working Width | 可纺纱线 Yarn count | 出条头数 No. of wool tops delivered | 生产能力 Output | 喂入次数 Feeding Frequency | 功率 Power |
|---------------------------|-----------------------|--------------------|------------------------------------|--------------------------|---------------------------|-------------|
| 二联梳毛机 Dual-Component | 1550mm | 1--8Nm | 80 或 120 80 or 120 PCS | 最大 30 米/分 Max 30m/min | 1.2--2.5 次/分 | 13.35 KW |
| 三联梳毛机 Triple-Component | | 10--16Nm | 120 或 144 120 or 144 PCS | | 1.2--2.5 times/min | 18.35 KW |
| 四联梳毛机 Quadri-Component | | 12--24Nm | 120 或 144 120 or 144 PCS | | | 18.35 KW |

梳毛机（翻新）

Woolen Spinning Machines After Fully Reconditioned

产品介绍

PRODUCT INTRODUCTION

设备经过彻底拆解，所有机件经过仔细检查和控制，根据经验修复或更换不良机件，保证所有部件处于良好工作状态。

Dismounting the machine into pieces, all the parts are carefully checked and controlled in good working condition.

对梳毛机的大锡林，道夫，工作辊，风轮，转移辊等进行精磨，以及静平衡和动平衡校正。大锡林，道夫，和工作辊的圆整度公差为0.03毫米。

Fine grinding, Static and Dynamic balance of all the main swifts, doffers, workers, fancy rollers, and transfer rollers of each carding set. The roundness tolerance is +/-0.03mm on main cylinders, doffers and workers.

机械类型：三联单过桥梳毛机；四联单过桥梳毛机；四联双过桥梳毛机

Machine Models: Woolen spinning machines with three card groups + one BBF

Woolen spinning machines with three card groups + one BBF

Woolen spinning machines with four card groups + two BBF

工作幅宽：Working Width: 2000mm, 2200mm, 2500mm

机械细节

Machine Details



主要规格及参数

全新喂毛机
全新喂料平帘，配备斜式推毛板
全新金属/弹性针布
全新V型驱动皮带，平皮带，和齿形带。
全新链条
全新驱动系统
全新欧洲知名品牌搓皮板/皮带丝，专纺羊绒羊毛产品。
全新电控动力柜，配备中文/英文显示触摸屏
所有大锡林和胸锡林两侧加装保护罩壳。
设备经过重新喷漆，外观像新设备。

MAIN SPECIFICATIONS AND PARAMETERS

Brand New Hopper Feeder
Brand New Feeding Conveyor, with Pushing bar on Feed table
Brand New Metallic/Flexible Card Clothing
Brand New: V Belts, Tooth Belts, and Flat Belts on Driving System
Brand new Transmission Drive
Brand New Rubbing Aprons/Condenser Tapes in famous brand in Europe, suitable for processing cashmere / Sheep Wool products.
Brand New Main Control Panel, touch screen in Chinese/English display
All the main cylinders and breast rollers have the side covers.
Re-painting of all the Cards look like new.